

Kids Sand Table

Copyright © 2014 Shanty-2-Chic.com

Supply List

Item	Quantity	Description
1 x 4 x 10'	3	Pine or whitewood boards
1 x 2 x 6'	1	Pine or whitewood boards
1 x 2 x 4'	1	Pine or whitewood boards
2 x 3 x 8	3	Pine or whitewood boards
1-1/4" Pocket Hole Screws	15	Coarse thread for lid slats
2-1/2" wood screws	32	For 2 x 3 frame
Brad nails	Handful	To attach the lower slats and lid trim
Wood glue		
Sand bin		

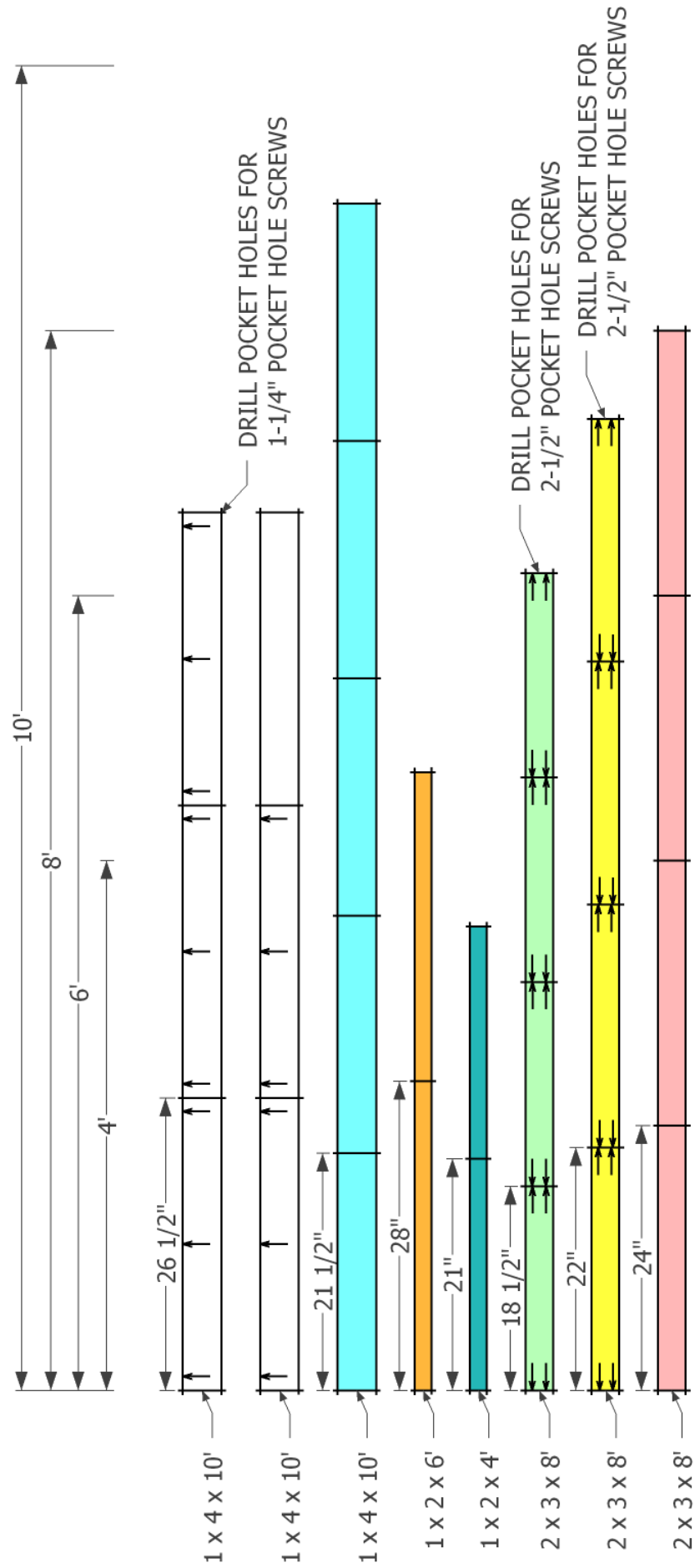

1

Assemble two sides of the frame. Use glue and two 2-1/2" pocket hole screws at each joint. The height of the bottom shelf is up to you but this model shows the bottom rail 1" off of the ground.

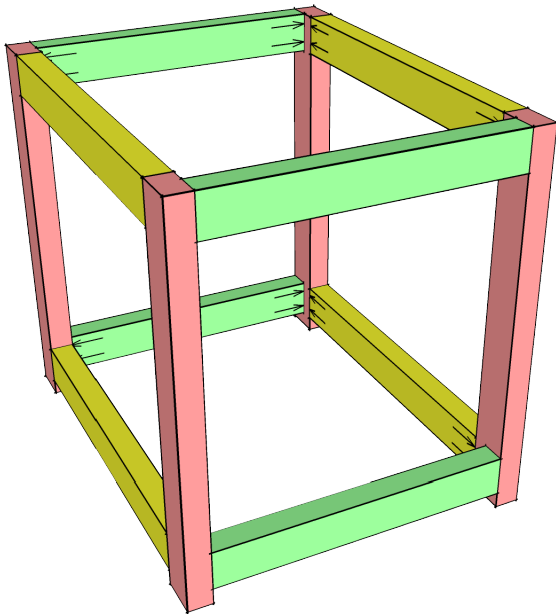
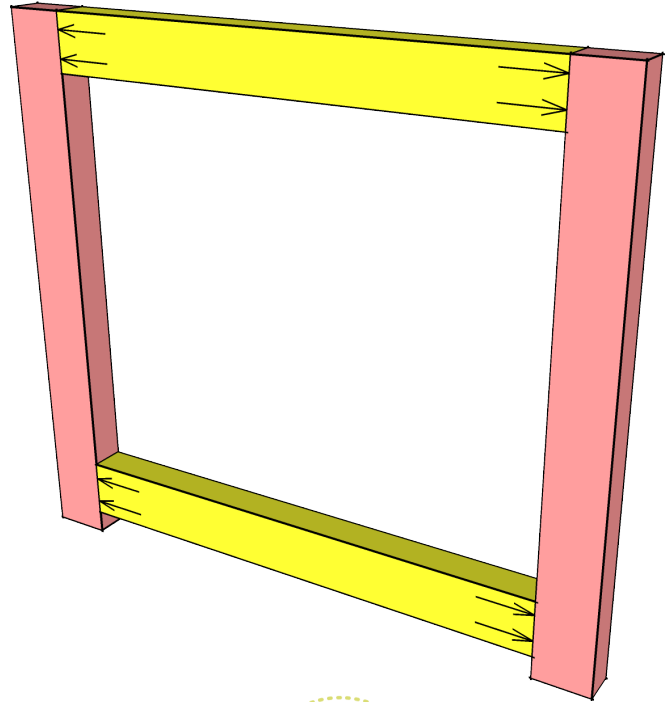

2

Connect the two sides with the remaining four rails in the same way. Make sure the bottom rail is the same height as before

3

Add the lower shelf slats. These are evenly spaced out and just tacked down with brad nails and glue.

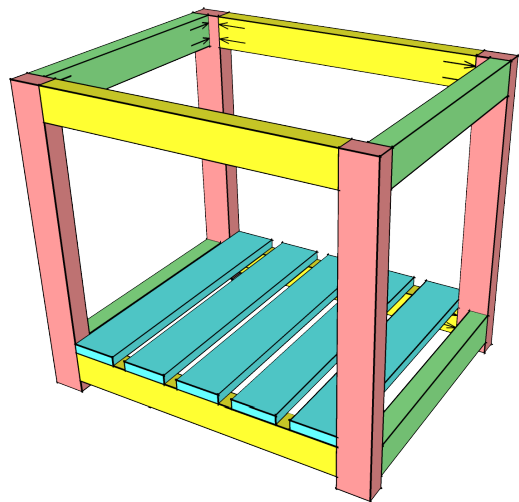

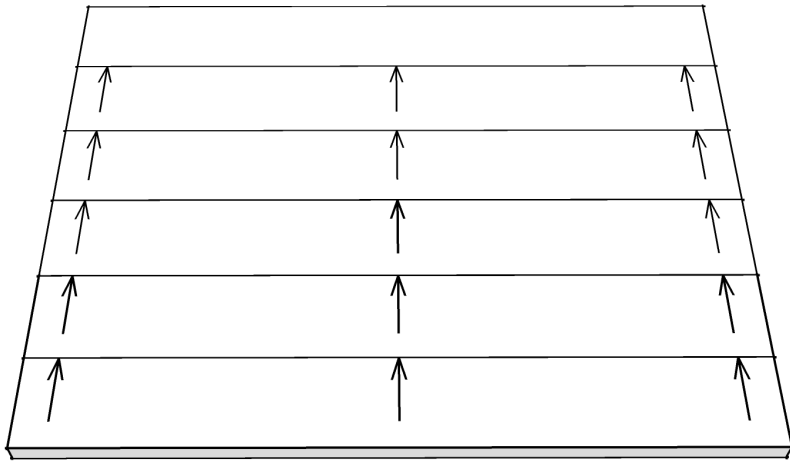

4

Assemble the lid slats with 1-1/4" pocket hole screws.

5

Attach the short trim pieces to the ends of the lid slats. Use glue and at least one brad nail per slat.

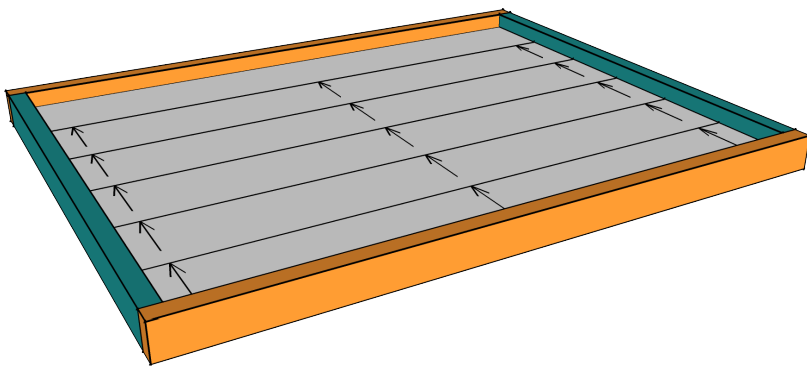
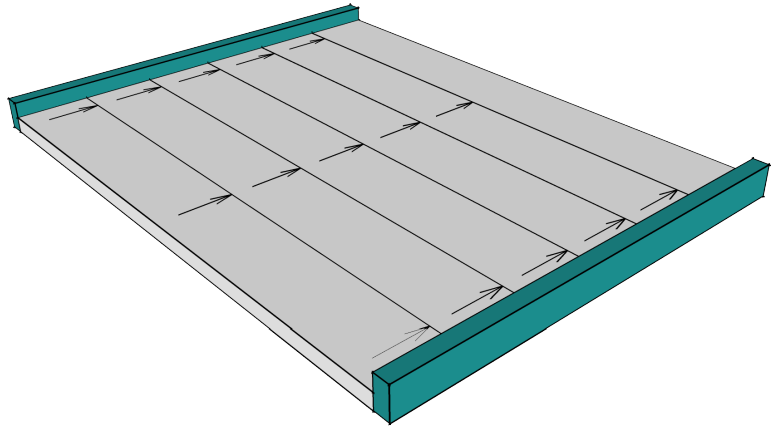

6

Add the final trim pieces to the top assembly, use glue and brad nails every six inches or so.