

DIY Double X Outdoor Table

Copyright © 2014 Shanty-2-Chic.com

Supply List

Item	Quantity	Description
2 x 6 x 6'	9	Pine or whitewood board
2 x 6 x 8'	2	Pine or whitewood board
2 x 4 x 8'	5	Pine or whitewood board
2-1/2" pocket hole screws	98	
2-1/2" wood screws	About 1lb	
Wood glue		
Finish of choice		

Drill pocket holes for 2-1/2" pocket hole screws as indicated by the arrows.

All angle cuts on the X pieces are 45 degrees and the legs are cut at 10 degrees. Some of these lengths may be a tad different for your exact table so measure and cut as you go. The top trim pieces are mitered on end and show the longest length in this cutting layout.

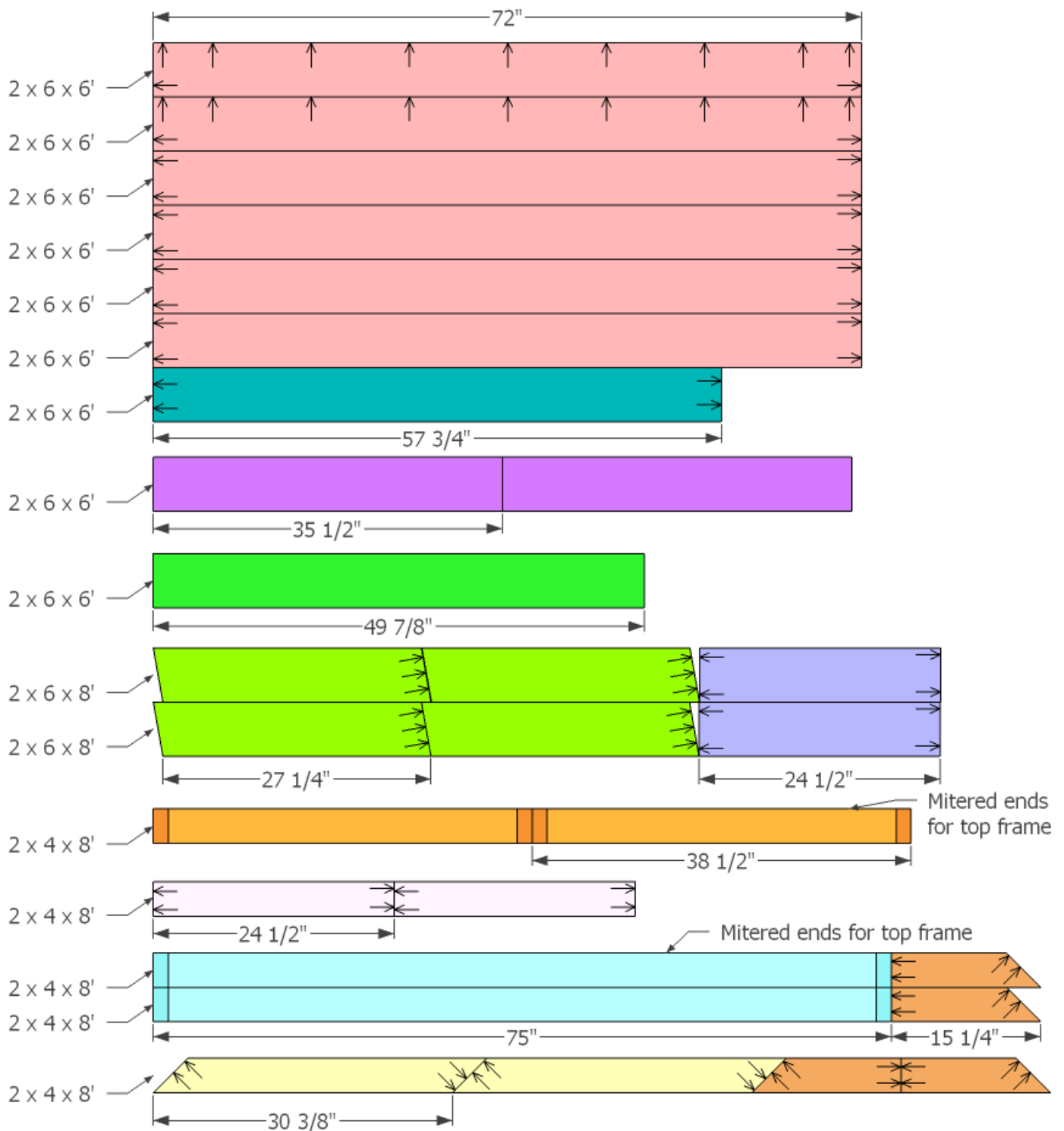

1

Layout your top frame pieces. The table will be built upside down. Pre-drill and countersink two 2-1/2" wood screws into each miter to connect them. These can be filled with wood filler later.

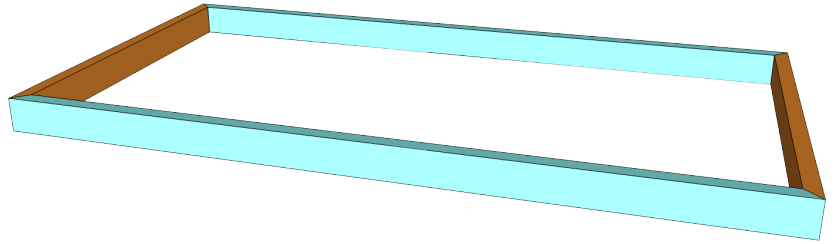

2

Add your top planks to the frame and secure them with pocket hole screws. Space the interior planks evenly. The measurements in this plan will leave a 1/2" gap between the top planks.

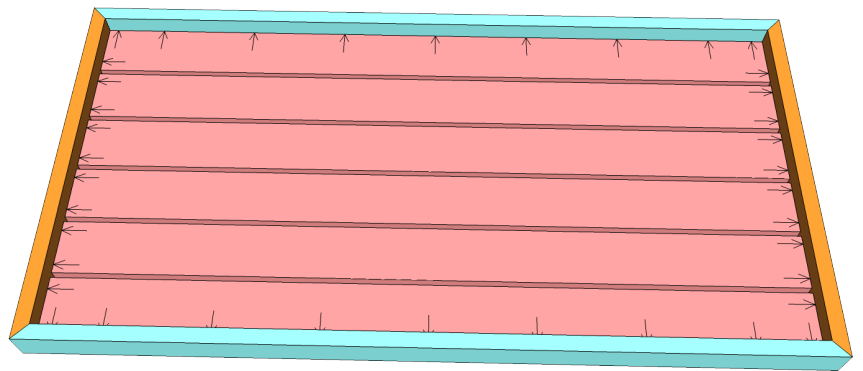

3

Assemble the legs separately. They are spaced evenly left to right. The 2 x 4 horizontal piece is spaced 16" parallel from the top of the legs and the 2 x 6 horizontal piece is spaced 23" parallel from the top of the legs.

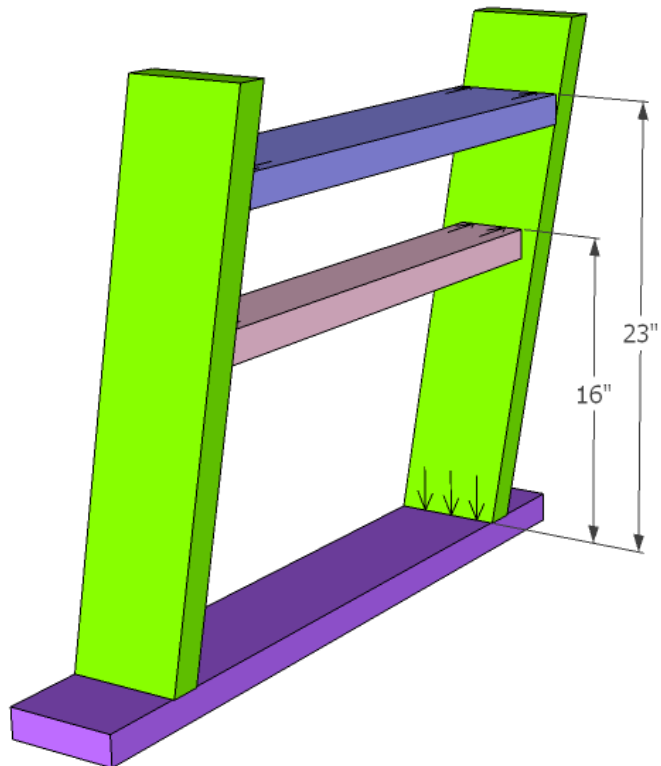

4

Add the leg assemblies and upper support to the bottom of the top assembly. Use 2-1/2" wood screws to attach everything.

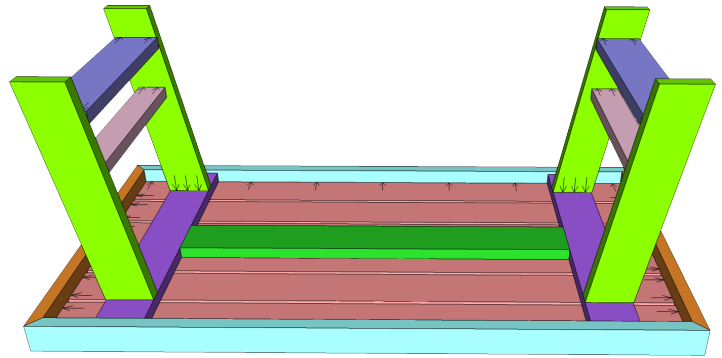

5

Add the lower stretcher. In a perfect world your's would be the exact length as indicated in this plan. If your legs are a tiny bit off of 10 degrees the length of this stretcher will vary. That's OK. Just cut your piece to the correct length.

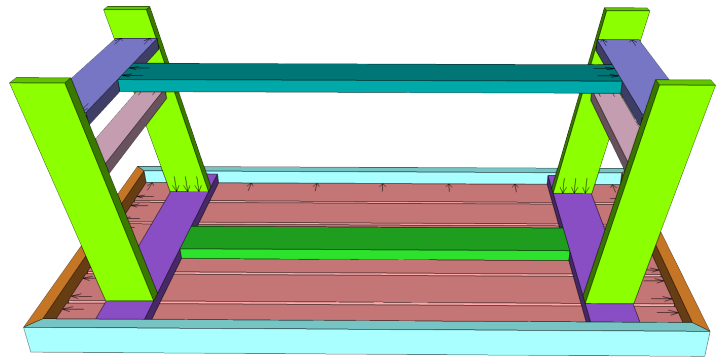

6

Again, measure and cut for the long parts of the X.

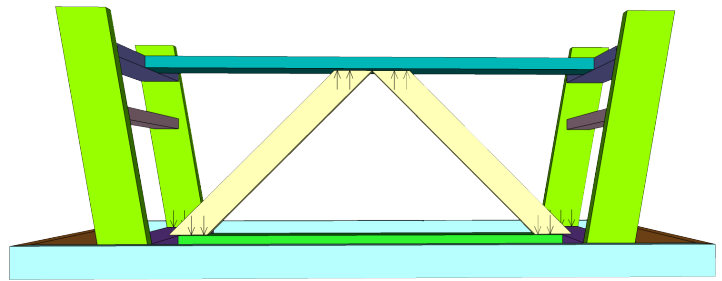

7

Add your smaller X parts, sand, and apply a finish of your choice. Now pat yourself on the back because you just saved a ton of money by making this awesome table. As always if you make one of these be sure to stop by our website and let us know!

