



©2017 WWW.SHANTY-2-CHIC.COM



# BARN DOOR VENT HOOD

## SUPPLY LIST

Item	Quantity	Description
1x4x8	4	Pine or Whitewood
1/4"x48"x96"	1	Hardwood Plywood (Birch)
1" Brad Nails		
1 1/4" Brad Nails		
Metal Corner Braces	4	
Wood Glue		

*Remember!*

Many of these cuts are best made as you go. If you have questions, check out the tutorial on our site!

## CUT LIST

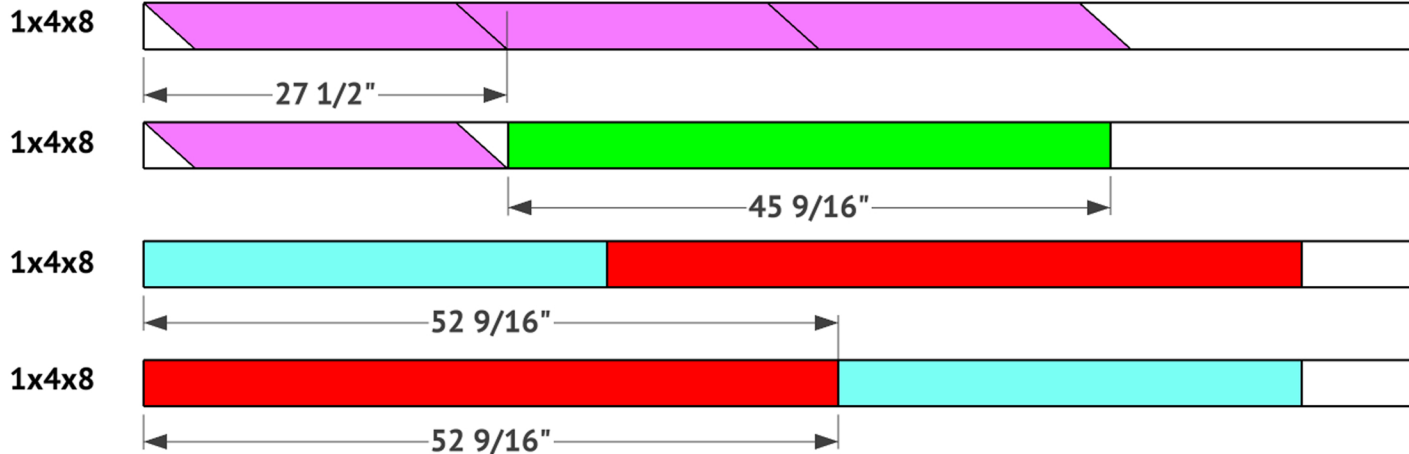

1/4"x4'x8'  
Hardwood Plywood

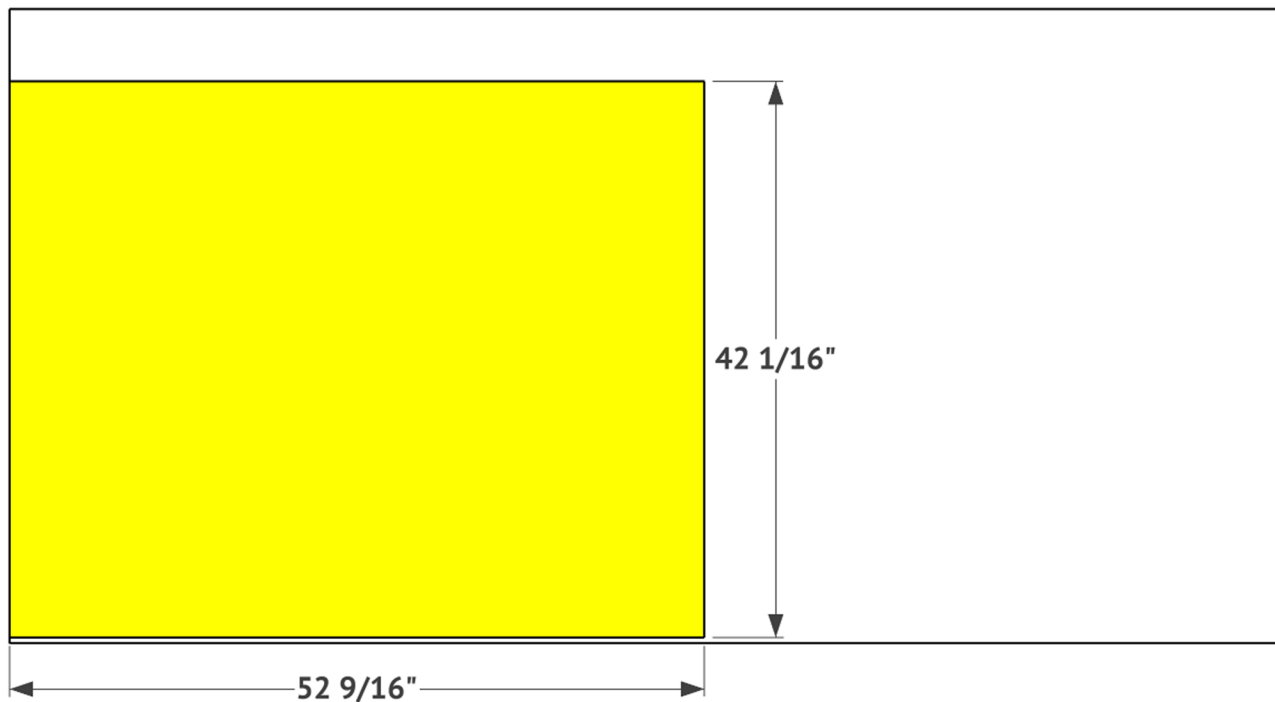

## MITER CUT DETAIL:



Note: Measurements are based on the size of my cabinets. Make sure to measure your cabinets and adjust the plans accordingly.

1

Cut a sheet of 1/4" hardwood plywood to cover the front of your cabinet box. Attach the plywood to the face frame of the cabinet with 1" brad nails and wood glue.

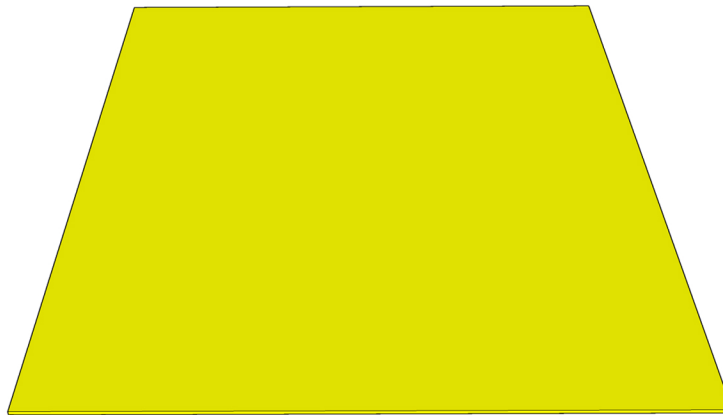

2

Cut the vertical trim pieces to size and attach them to the 1/4" plywood with 1 1/4" brad nails and wood glue. All edges of the trim should be flush with the plywood.

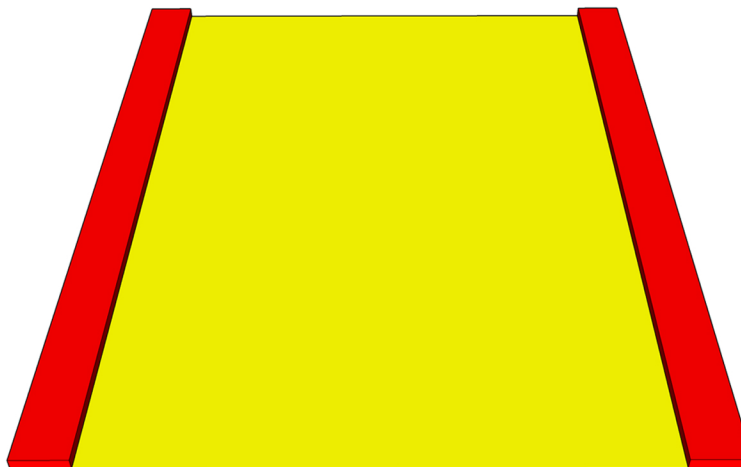

3

Cut the top and bottom trim to size and attach it to the plywood with 1 1/4" brad nails and wood glue.

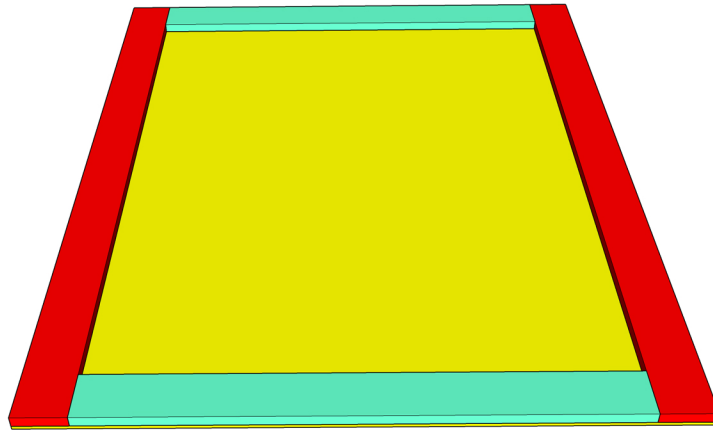

4

Cut the middle trim piece to size, center it on the plywood and attach with 1" brad nails and wood glue.

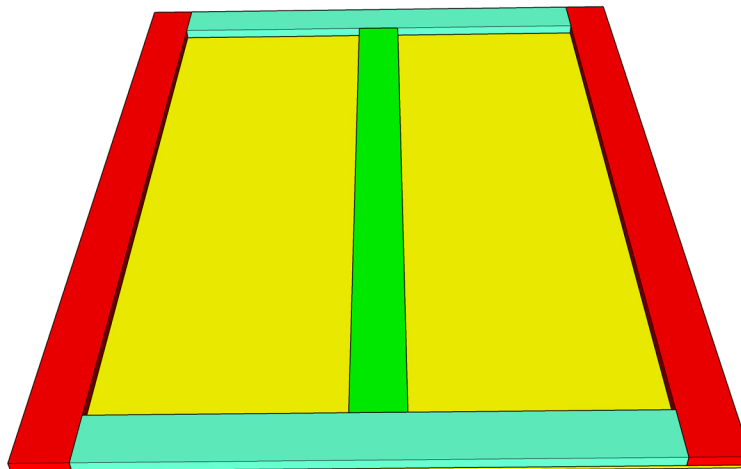

5

Cut the angle pieces to fit. To get the best fit, hold an angle piece up to the trim and mark where the cut should be. Attach with 1" brad nails and wood glue.

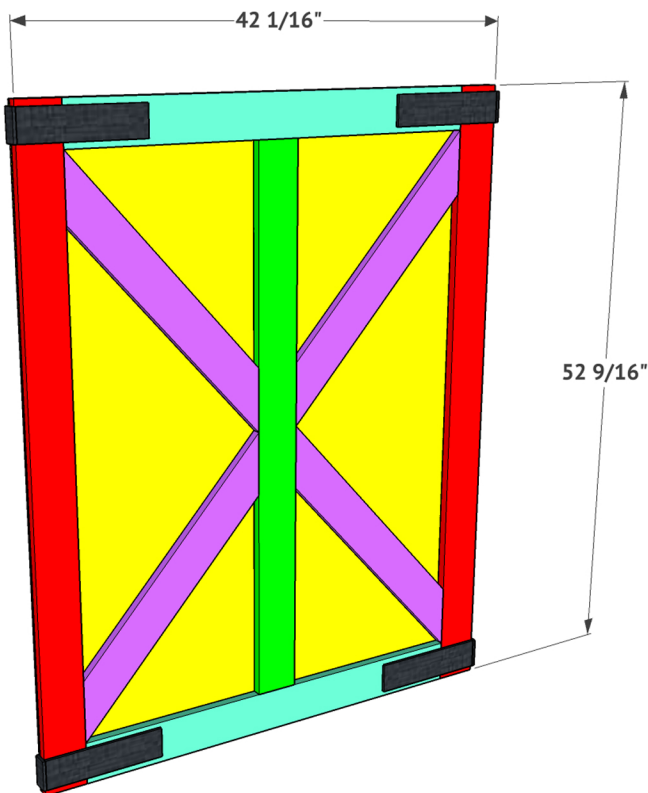
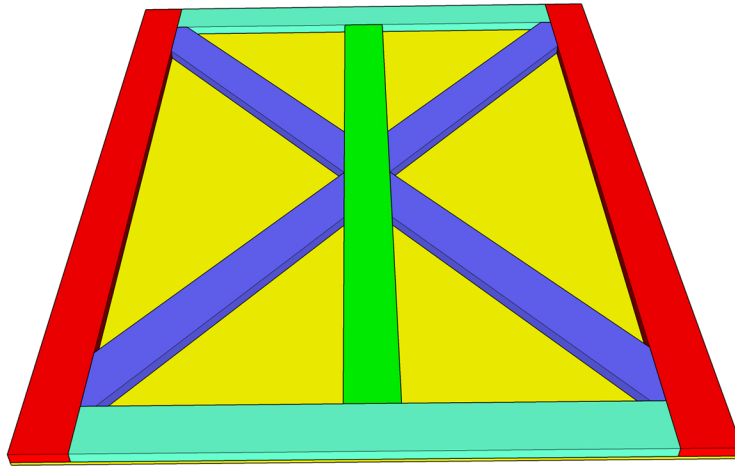

Fill your nail holes and add a finish! I spray painted metal corner braces and attached them with hex screws. Make it your own and make sure to share your builds with us on social media and use #shanty2chic so we can share them too!

Happy Building!