



©2017 WWW.SHANTY-2-CHIC.COM



DIY Full Size Bed w/ Fancy Headboard









SUPPLY LIST

Item	Quantity	Description
2x8x8	12	Framing Lumber
2x6x8	1	Framing Lumber
1x4x8	12	Furring Strips
Furniture Feet	4	Link in Post on our Site
2 1/2" Pocket Hole Screws		
1 1/4" Wood Screws		
2 1/2" Wood Screws		
4" Wood Screws		
Wood Glue		

Remember!

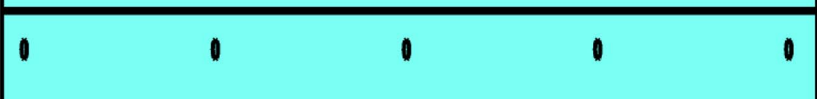
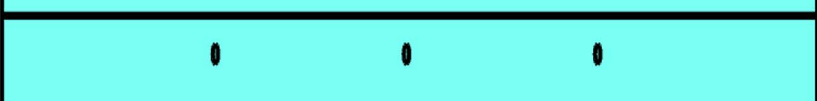
Many of these cuts are best made as you go. If you have questions, check out the tutorial on our site!

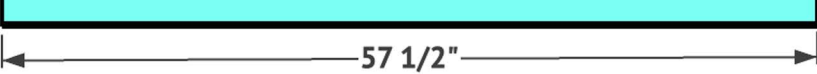
CUT LIST (page 1)

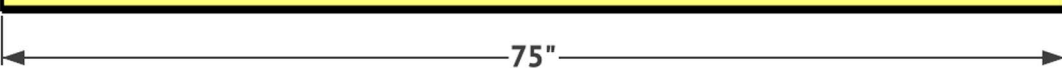
2x8x8		
2x8x8		
2x8x8		
2x8x8		
2x8x8		
2x8x8		
2x8x8		
2x8x8		
		
2x8x8		
2x8x8		
		

Remember!

Many of these cuts are best made as you go. If you have questions, check out the tutorial on our site!

CUT LIST (page 2)

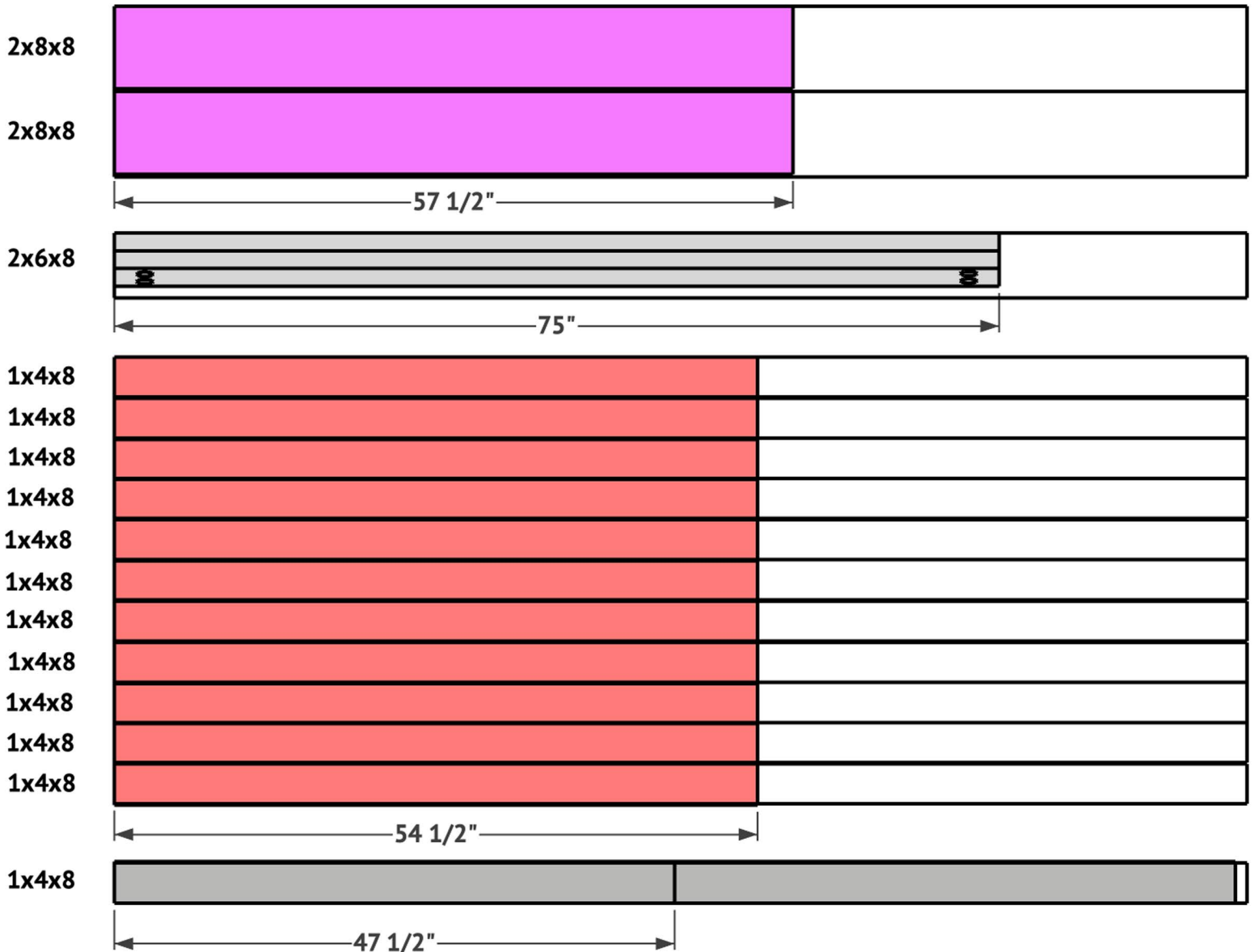

Note: I ripped my 2x8 boards down to 7" wide. This is not a necessary step but if you choose not to rip your boards, adjust the plans accordingly.

1

Cut the headboard planks to size and drill 1 1/2" pocket holes in all of the planks except one (note the placement of the pocket holes in the top three planks). Attach 7 of the planks together with 2 1/2" pocket hole screws.

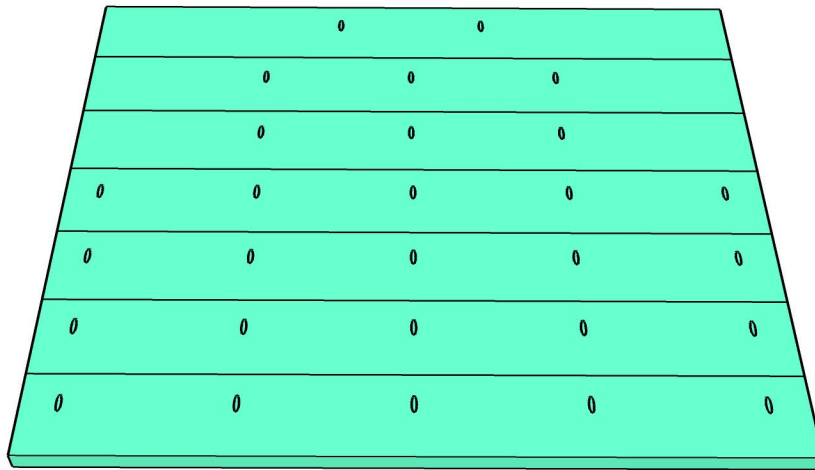

2

Mark 16" on the top corners of the headboard. Draw an arc from one point to the other and cut the arcs with a jigsaw.

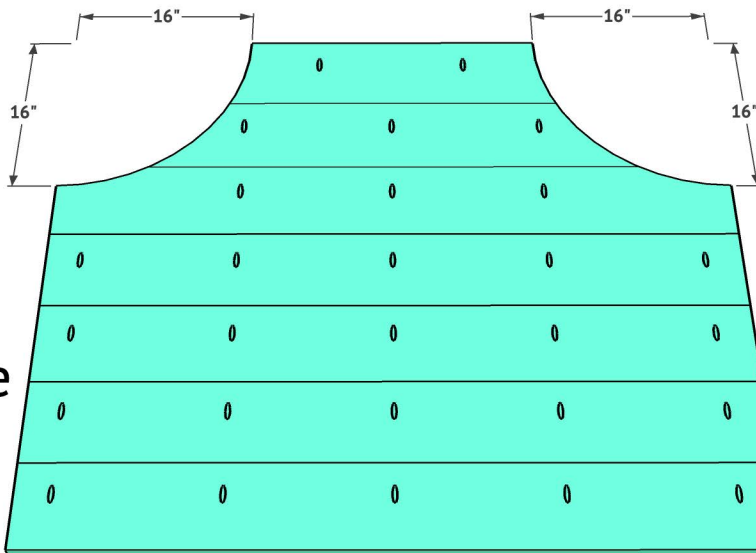

Watch our how-to video for more detail on how we made these cuts.

3

Cut the back supports to size and attach them to the back of the headboard with 1 1/4" wood screws and wood glue.

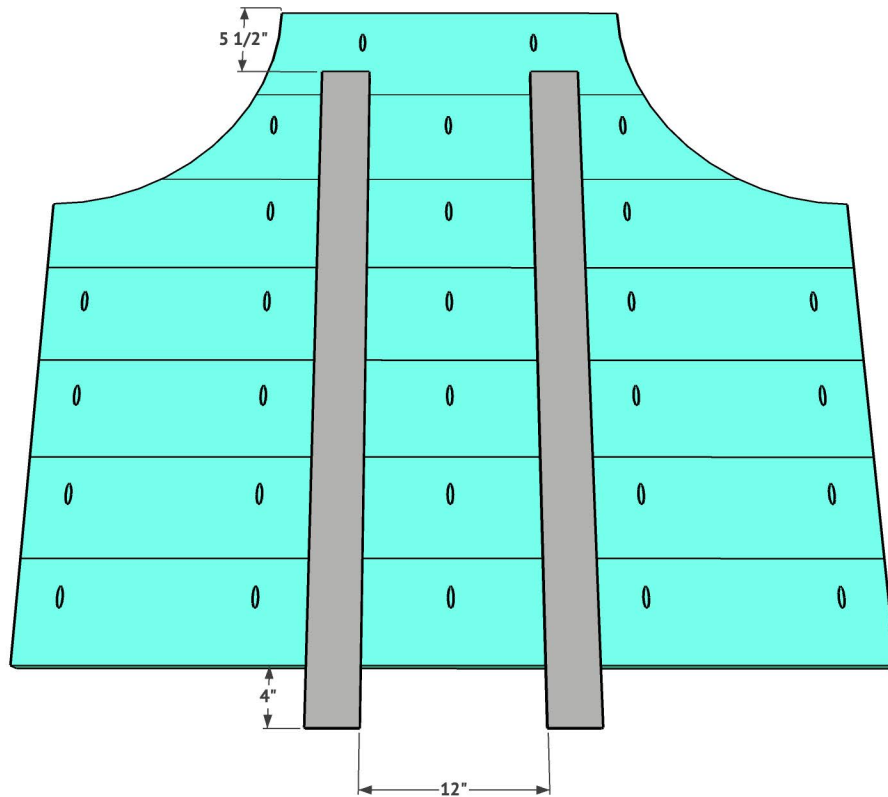

4

Cut the bed frame to size and drill 1 1/2" pocket holes at both ends of the side rails. Attach the side rails to the headboard and footboard with 2 1/2" pocket hole screws and wood glue.

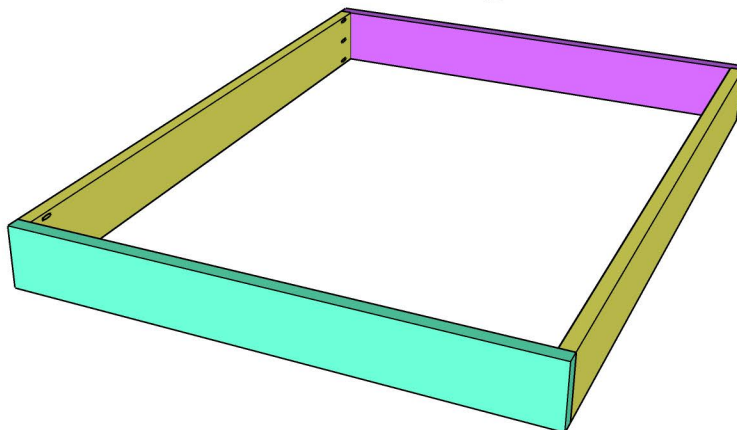

5

Attach the feet to the inside corners of the bed with 4" wood screws and wood glue. The bottom of the block, at the top of the feet, should be flush with the bottom of the bed frame.

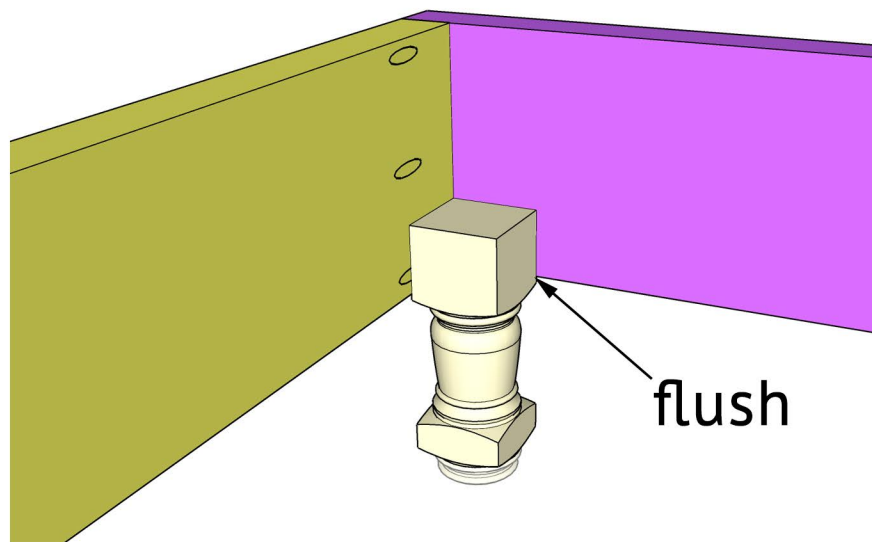

6

Cut the cleats to size and drill 1 1/2" pocket holes at both ends of the center cleat. Attach the side cleats with 2 1/2" wood screws and wood glue. Attach the center cleat with 2 1/2" pocket hole screws and wood glue.

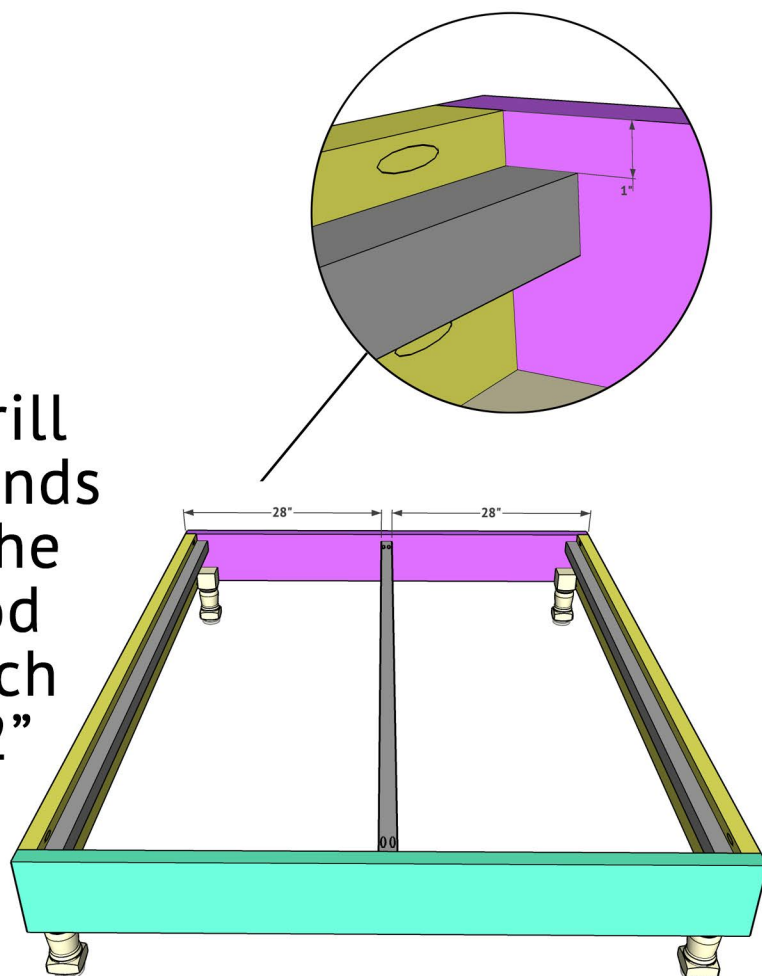



Rest the headboard on top of the bed frame and attach it to the back rail with 2 1/2" wood screws, through the back supports and into the back of the bed frame. Then, follow up with 2 1/2" pocket hole screws, from the bottom headboard plank into the back rail for added support.

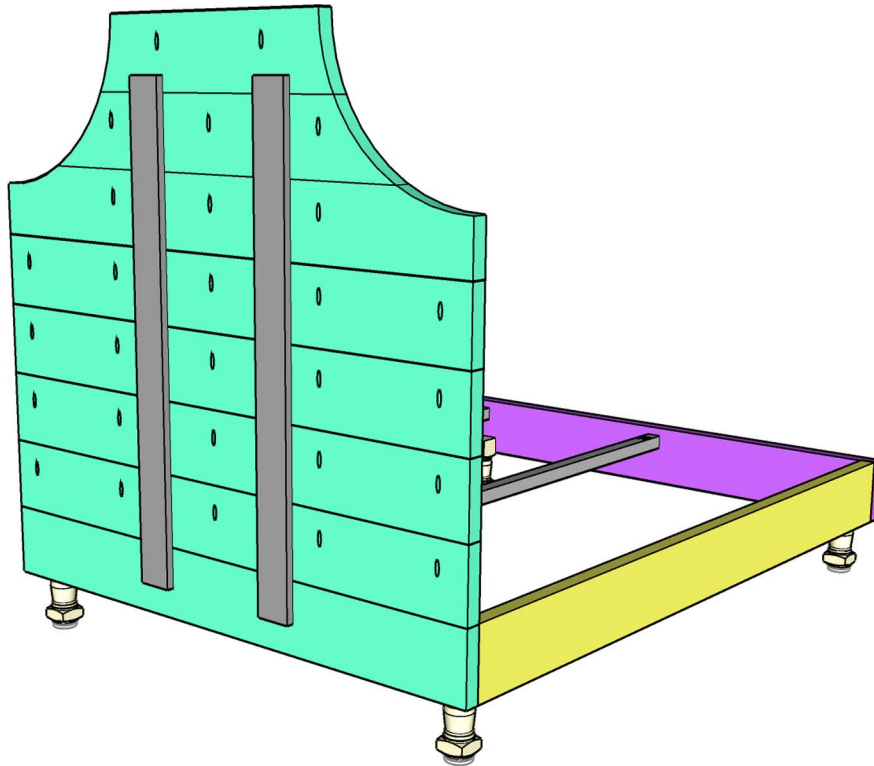

Cut the slats to size and attach them to the cleats with 1 1/4" wood screws and wood glue.

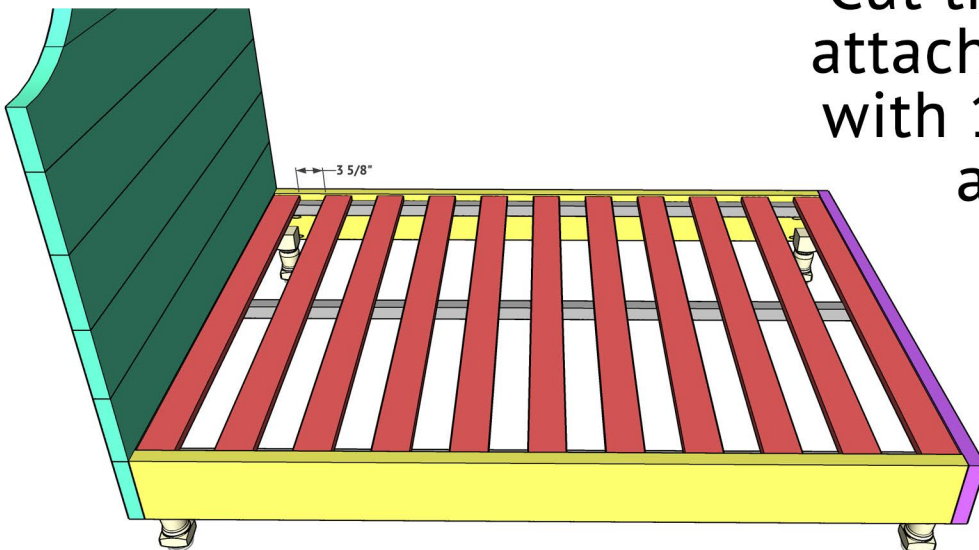

Give the entire bed a good sanding, fill any exposed holes with wood filler and add a finish!

Make sure to share your builds with us on social media and use #shanty2chic so we can share them too!

Happy Building!

