



©2017 WWW.SHANTY-2-CHIC.COM



# DIY Planter Box

## SUPPLY LIST

Item	Quantity	Description
1x6x8	8	Cedar Fence Pickets
2x4x8	2	Framing Lumber
3/4" Wood Screws		
2 1/2" Pocket Hole Screws		
1 1/4" Brad Nails		
1" Brad Nails		
Wood Glue		

*Remember!*

Many of these cuts are best made as you go. If you have questions, check out the tutorial on our site!

## CUT LIST (cut list is for one planter box)

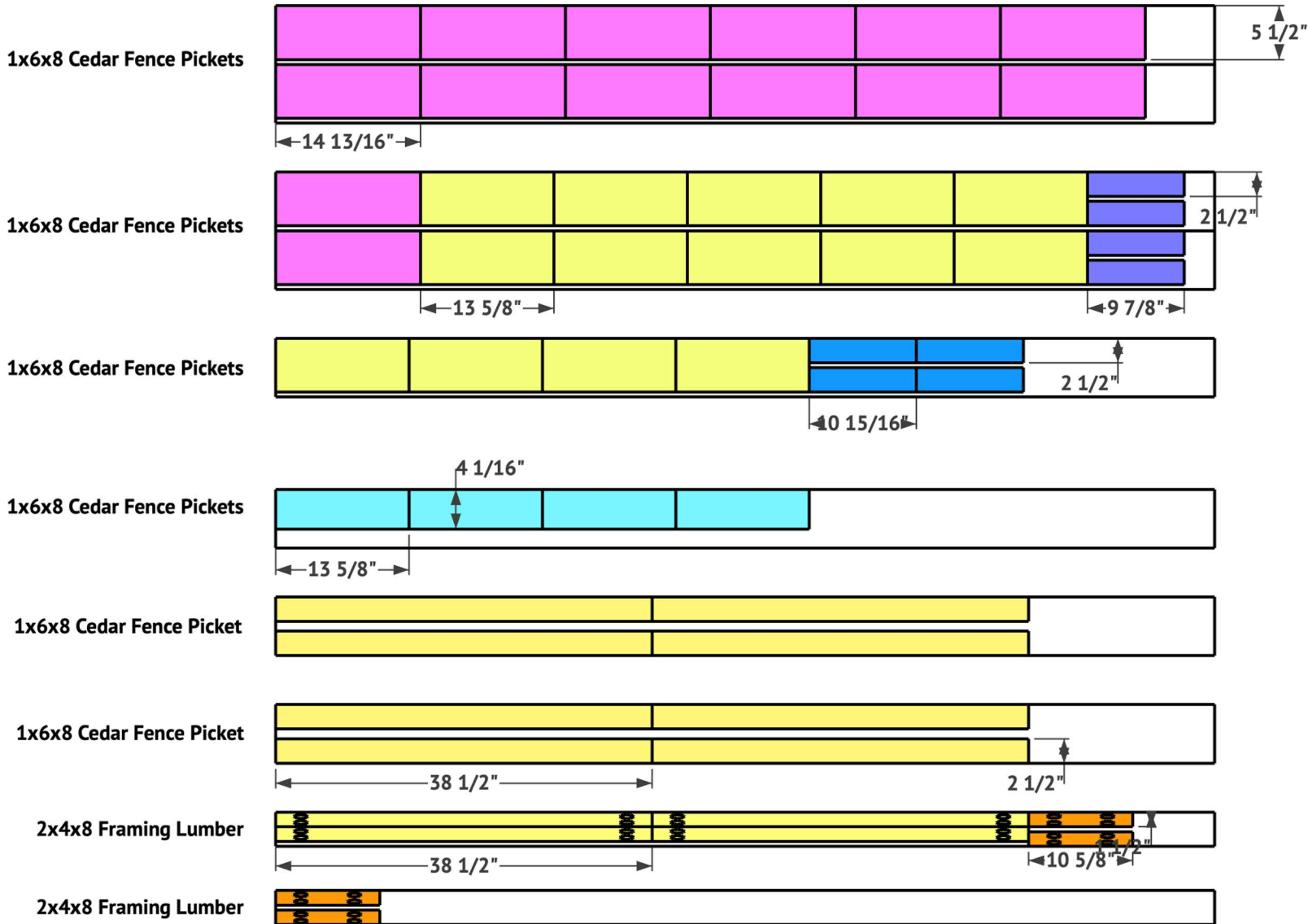

1

Cut the frame pieces to size. Drill 1 1/2" pocket holes at both ends of the short rung pieces. Attach them to the long frame pieces with 2 1/2" pocket hole screws and wood glue.

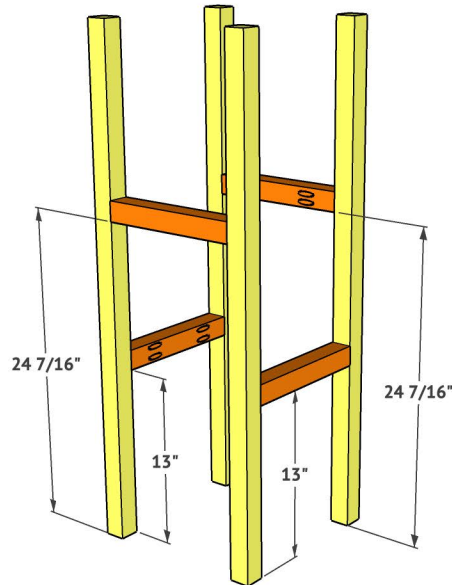

2

Cut the bottom slats to size and lay them in place inside the frame. You do not need to secure these pieces.

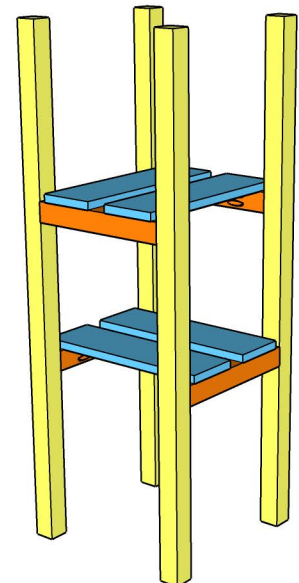

3

Cut the short slat pieces to size and attach them to opposite sides with 3/4" wood screws and wood glue. The slats should be flush with the ends of each frame.

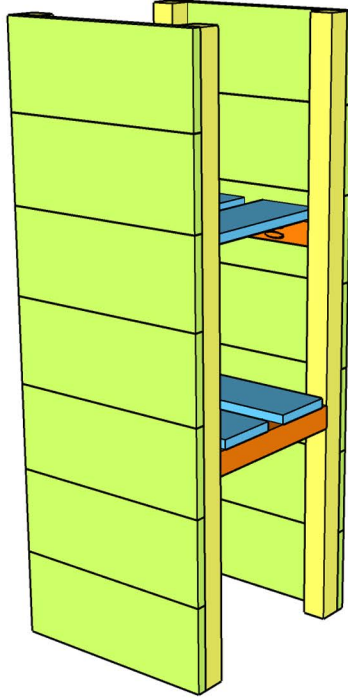

4

Measure and cut for the long slat pieces and attach them the same way, on the two remaining sides of the planter box. The long slats should be flush with the edges of the short slats.

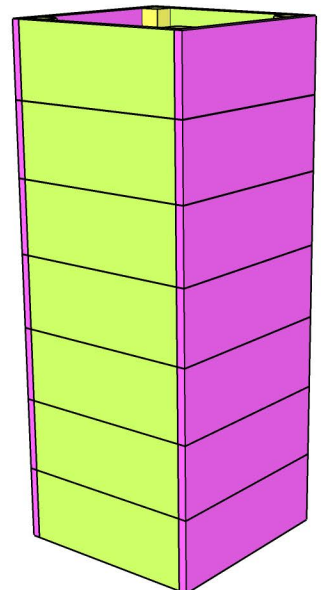

5

Measure and cut the side trim pieces to size and attach the first set of trim pieces, on the short slat sides, of the planter box with 1 1/4" brad nails and wood glue. The trim pieces should be flush with the ends of the long slats and the top and bottom of the frame.

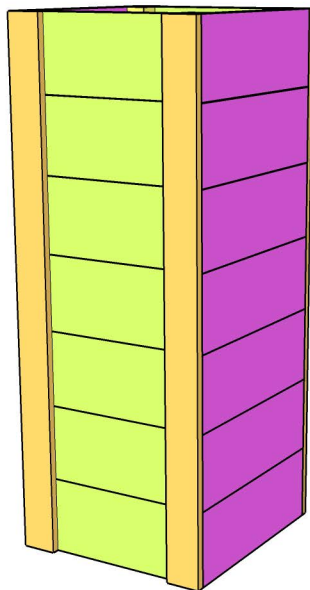

6

Attach the remaining long trim pieces to the long slat sides with 1 1/4" brad nails and wood glue. They should be flush with the short slat trim pieces, so that they cover the edges of the long trim on the short slat side.

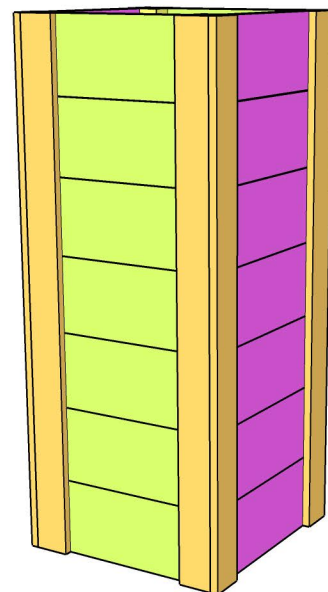



Measure and cut the short top trim pieces to size and attach them to the top and bottom of both short sides of the planter box with 1" brad nails and wood glue. The trim pieces should be flush with the top and bottom of the planter box.

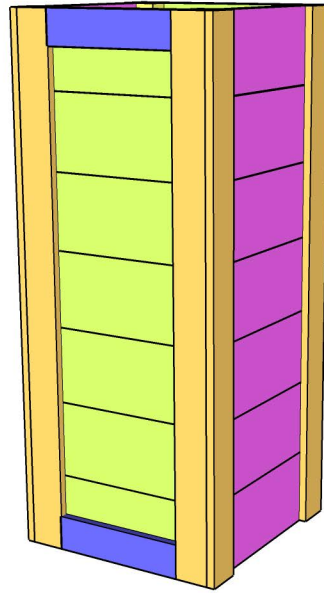

Measure and cut the long top trim pieces to size and attach them the same way.

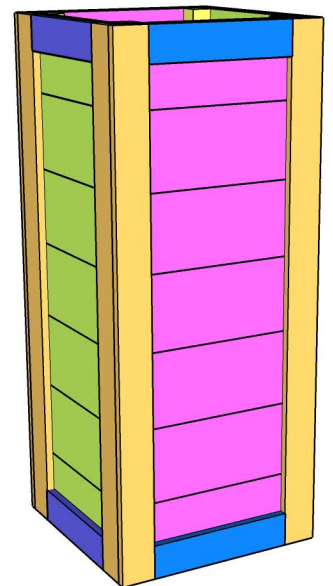

All finished!

You can paint it or stain it if you prefer or just add an outdoor clear coat protectant to show off the beautiful cedar!

Make sure to share your buids with us on social media and use #shanty2chic so we can share them too!

Happy Building!

